

Serie Idegis Domotic

Idegis Domotic Series

Idegis Domotic PLUS

PoolStation[®]
compatible

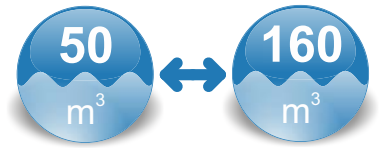

Relájese, Domotic
se encarga de todo

Relax, Domotic does
it all

VENTAJAS / ADVANTAGES

- Comunicaciones:
Modbus y Poolstation.

- Control remoto:
cable (opcional)

- Communications:
Modbus & Poolstation.

- Remote control:
cable (optional)

DESCRIPCIÓN

- Menú configuración sistema

- Auto-diagnóstico célula.

- Función test de sal.

- Porta sondas y válvula de
inyección de pH minus integrado.

DESCRIPTION

- System Setup Menu

- Cell self-check.

- Salt test function.

- Integrated probe-holder and
pH minus injection valve.

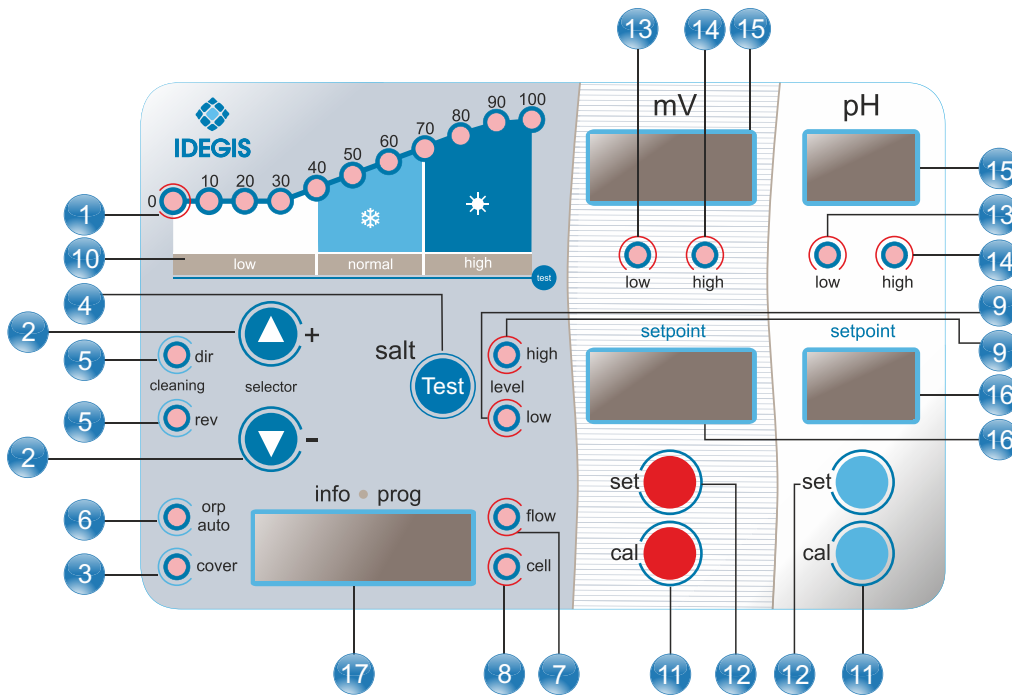

PANEL DESCRIPTIVO / PANEL DESCRIPTION

- | | |
|--|--|
| <ul style="list-style-type: none"> 1. Escala de producción (%).
Production Scale (%). 2. Teclas \blacktriangle aumentar / disminuir producción.
Keys \blacktriangle increase / decrease output. 3. Indicador control cubierta automática activado
Indicator of activated automatic cover control. 4. Test de salinidad
Salinity test 5. Indicadores auto-limpieza (polaridad directa/inversa).
Self-cleaning indicators (direct/reverse polarity). 6. Indicador control ORP activado (modo auto).
Indicator of activated ORP control (auto mode). 7. Indicador de Alarma de FLUJO
Indicator of Flow alarm. 8. Indicador de alarma de célula pasivada.
Indicator of electrode passivation alarm. 9. Indicadores de salinidad alta y baja.
Indicators of high and low salinity. | <ul style="list-style-type: none"> 10. Escala de salinidad (Cualitativa).
Salinity scale (qualitative). 11. Teclas para modo calibracion (pH y ORP).
Keys for calibration mode (pH and ORP). 12. Tecla para programar el valor de pH/ORP deseado.
Key for pH/ORP setpoint programming. 13. Indicador de alarma pH/ORP bajo (pH <6.5, mV < 650)
Indicator of low pH / ORP alarm. 14. Indicador de alarma pH/ORP alto (pH >8.5, mV > 850)
Indicator of high pH / ORP alarm. 15. Pantalla de indicación del valor de pH/ORP del agua.
Display of water pH / ORP. 16. Pantalla de indicación del valor de pH/ORP programado.
Display of the pH / ORP setpoint. 17. Pantalla de información/configuración del sistema.
Display of system information/configuration. |
|--|--|

Idegis Domotic Series

Referencia-Reference			Producción-Production	Piscina-Pool
DOMOTIC	DOMOTIC pH	DOMOTIC PLUS	Electrolisis salina Salt electrolysis	Hasta Up to
DOM-12	DOM-12 pH	DOM-12 +	12 gr Cl ₂ /hr	50 m ³
DOM-24	DOM-24 pH	DOM-24 +	24 gr Cl ₂ /hr	80 m ³
DOM-32	DOM-32 pH	DOM-32 +	32 gr Cl ₂ /hr	120 m ³
DOM-42	DOM-42pH	DOM-42 +	42 gr Cl ₂ /hr	160 m ³



Serie Idegis Domotic

Idegis Domotic Series



Fuente de Alimentación / Power Supply

Modelo / Model

Descripción/Description	DOM12/pH/+	DOM24/pH/+	DOM32/pH/+	DOM42/pH/+
Tensión de servicio / Input voltage	230 V ac 50/60 Hz.			
Consumo / Consumption (A ac)	0.36 A	0.72 A	0.89 A	0.89 A
Fusible / Fuse (5x20mm)	2AT	3.15AT	4AT	4AT
Salida / Output (Adc)	12 A (2 x 6A)	24 A (2 X 12 A)	32 A (2 x 16 A)	42 A (7 X 6 A)
Producción / Production (gr Cl ₂ /hr)	10 - 12	20 - 24	25 - 32	32 - 42
m ³ Piscina / Pool (16 - 24° C)	60	100	160	200
m ³ Piscina / Pool (+25° C)	50	80	120	160
Salinidad / Salinity	Estándar / Standard: 5 - 12 g/l (5 - 6 g/l recomendado / recommended)			
Temperatura ambiente / Room temperature	max. 40°C			
Envolvente / Enclosure	ABS			
Inversión polaridad / Polarity reversal	2h,3h y test (menu config.) / 2h,3h and test (config menu)			
Control producción / Production control	0-100% (11 niveles de producción) / 0-100% (11 production levels)			
Detector de flujo (gas) Flow Sensor (gas)	Menu config.: activo-inactivo. Led flow Config menu: enabled-disabled. Led flow			
Detector flujostato Flow-switch sensor	Menu config.: activo-inactivo. Led flow. Sensor no incluido Config menu: enabled-disabled. Led flow. Sensor not included			
Control Producción por cobertor Production Control for cover	Menu config 9 estados (10...90%), (0,NC,NO). Contacto libre de tensión. Led COVER. Config menu 9 levels (10 ... 90%), (O,NC,NO). Potential-free input. COVER Led.			
Control Producción Externo External Production Control	Menu config 2 estados (0, set%), (O,NC). Contacto libre de tensión. Led ORP. Config menu 2 levels (0, set%), (O,NC). Potential-free input. ORP Led.			
Diagnos. Electrodo / Check cell function	Led Check Electrodes / Check Electrodes Led			
Paro seguridad pH / Pump Stop	Si, config. soft 1...99min / Yes, soft config 1 ... 99min			
Test salinidad (cualitativo) / Salinity test (qualitative)	Tecla test, 7 niveles conductividad / Key test, 7 conductivity levels			
Indicador Alarma sal / Salt alarm indicators	Alta y baja. 2 Leds / High and low. 2 LEDs			
Menú Conf. Sistema / Setup menu	Display informativo / Information display			
Control remoto (cable) / Remote control (cable)	Hasta 50 metros / Up to 50 meters			
Modbus & Poolstation (compatible)	Sí / Yes			

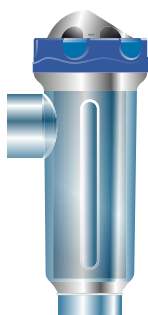

Célula de Electrolisis / Electrolysis Cell

Modelo / Model

Descripción/Description	DOM12/pH/+	DOM24/pH/+	DOM32/pH/+	DOM42/pH/+
Electrodos (titanio activado autolimpiante) Electrodes (self-cleaning titanium activated)	Premium Grade: 10.000 - 12.000 hr			
Caudal mín.(m ³ /h) / Flow min. (m ³ / h)	2	4	6	8
Número de electrodos / Number of electrodes	5	7	7	13
Material	Derivado metacrilato / Methacrylate derivate			
Conexión a tubería / Line connection	Encolado PVC Ø 63 mm / Gluing PVC Ø 63 mm			
Presión máxima / Maximum pressure	1 Kg/cm ³			
Temperatura trabajo / Working temperature	15 - 40°C max			

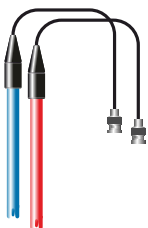

Controlador de pH and ORP / pH and ORP Controller

Modelo / Model

Descripción / Description	DOMpH / DOM+
Rango de media / Measure range	0.0 - 9.9 (pH) / 0 - 999 mV (ORP)
Rango de control / Control range	7.0 - 7.8 (pH) / 600 - 850 mV (ORP)
Precisión / Precision	± 0.1 pH / ±1 mV (ORP)
Calibración / Calibration	Automática mediante disoluciones patrón/ Automatic with calibration solution
Salidas control (pH) Control outputs (pH)	Una salida 230 V / 500 mA ac máx (conexión bomba dosific.) One output 230 V / 500 mA ac max (dosing pump connection.)
Sensores pH/ORP pH/ORP sensors	Cuerpo epoxy 12x150mm, electrolito solido. Rango 0-12 pH, 0-1000 mV Epoxy body 12x150mm, solid electrolyte. Range 0-12 pH, 0-1000 mV



Portasondas / Electrode Holder

Incluido / included (DOMpH / DOM+)

Dimensiones / Dimensions

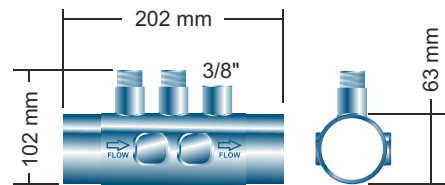

Diagrama de instalación / Installation Diagram

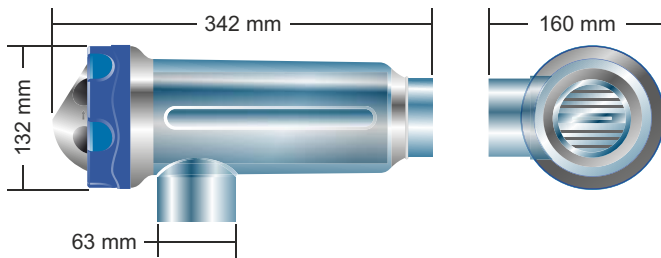
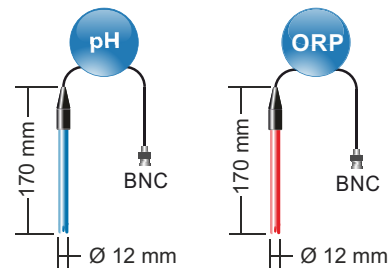
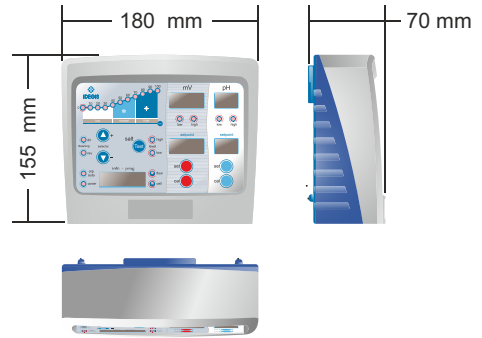